



APPROXIMATE SIZE: 15" x 13" x 5"





Approximate Size: 15" x 13" x 5"

FABRIC REQUIREMENTS

	<p>Fabric A 28728 X 1 1/8 YARDS 1 BOLT</p>		<p>Fabric B 23528 R 7/8 YARD 1 BOLT</p>	<p>OTHER MATERIALS</p> <ul style="list-style-type: none"> <li>• 1 Yard Sew in Fleece</li> <li>• 3/8 Yard Iron on Interfacing</li> <li>• 1 1/2 Yards of 1/8" Cotton Cording</li> <li>• 4 1/2" x 14 1/2" piece of Cardboard</li> </ul>
---	--	---	---	--

Information within gray box = Number of Bolts or Packs needed to make 12

We recommend that you carefully read through all instructions before starting your project.

## CUTTING DIRECTIONS

**Note:** WOF= width of fabric from selvage edge to selvage edge

### Fabric A, cut:

- (1) 11¼" x WOF strip.  
Subcut into (2) 11¼" x 21" front and back pieces.
- (1) 10" x WOF strip.  
Subcut into (2) 10" x 21" pocket pieces.
- (1) 6" x WOF strip.  
Subcut into (2) 6" x 16" bag and lining bottom pieces.
- (1) 5½" x WOF strip.  
Subcut into (2) 5½" x 15½" bottom insert pieces.

### Fabric B, cut:

- (1) 14" x WOF strip.  
Subcut into (2) 14" x 21" front and back lining pieces.
- (1) 3¾" x WOF strip.  
Subcut into (2) 3¾" x 21" top bands.
- (2) 3" x WOF strips.  
Subcut into (2) 3" x 32½" handle strips.
- (1) 1½" x WOF strip.  
Subcut into (2) 1½" x 21" cording cover strips.

## DIRECTIONS

Use a ½" seam allowance, unless otherwise directed.

1. Cut (2) 21" cording pieces. With wrong sides together and raw edges even, encase the cording in each **Fabric B** cording cover strip. Stitch next to the cording using a zipper or cording foot. Trim seam allowance to ½", if necessary.

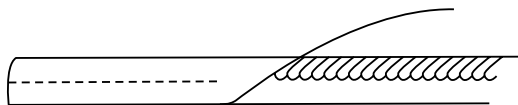

2. Pin the cording to the 21" top edge of the **Fabric A** bag front piece with the raw edge of the bag and the raw edge of the cording even. Stitch in place using a cording or zipper foot. Repeat with the second piece of cording and the **Fabric A** bag back piece.

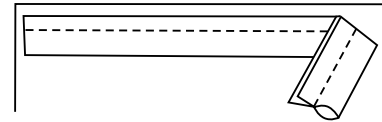

3. Iron the interfacing to the wrong side of the **Fabric B** handle strips.

4. Fold each handle piece in half lengthwise, with right sides together, and stitch along the long edge.

5. Turn right side out, press and stitch ¼" from each long edge.

6. Measure and mark 7" in from each side edge of the bag front. Pin the ends of a handle at the marks, aligning the raw edge of the handle with the raw edge of the bag front. Stitch in place. Repeat with the remaining handle and the bag back.

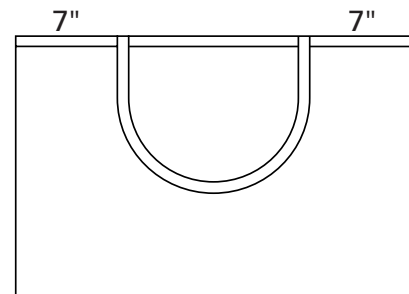

7. With right sides together, stitch a **Fabric B** top band to the bag front. Repeat with the remaining top band and bag back. Press seams up toward the top band, leaving the piping on top of the bottom piece.

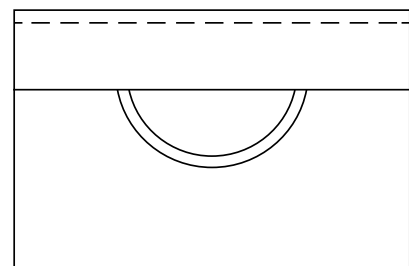

- 8.** Stitch each handle to the top band, stopping  $1\frac{1}{2}$ " from the top raw edge.

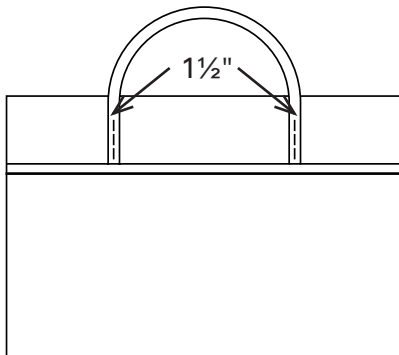

- 9.** Baste the sew-in fleece to the bag front, bag back and **Fabric A** bag bottom. Quilt, if desired.
- 10.** With right sides together, stitch the front and back bag sections together along the side edges. Press seams open. Do not turn right side out.
- 11.** Mark the center of each end of the bag bottom and lining bottom. With right sides together, pin the bottom to the bag, aligning the bag side seams with the center marks. Stitch the bag bottom to the bag. Turn right side out to complete the outer bag. Set aside.
- 12.** Turn the top 21" edge of each **Fabric A** pocket piece under  $\frac{1}{4}$ ", then  $\frac{1}{4}$ " again. Press. Topstitch to hem.
- 13.** Baste a pocket right side up to the right side of the **Fabric B** front lining piece. Divide the pocket in half and stitch from the top of the pocket to the bottom, making 2 pocket sections.

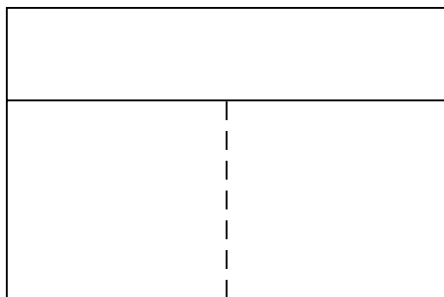

- 14.** Baste the second pocket to the **Fabric B** back lining piece. Measure 7" from each side raw edge and stitch from the top of the pocket to the bottom, making 3 pocket sections.

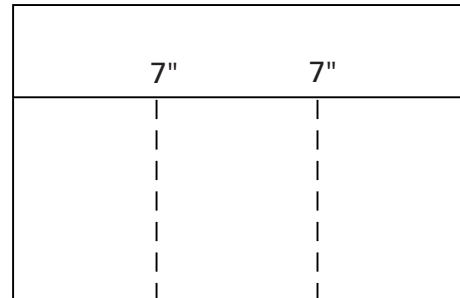

- 15.** With right sides together, stitch the front and back lining pieces together along the side edges. Press seams open.
- 16.** In the same manner as step 11, stitch the **Fabric A** lining bottom to the bag lining, leaving a 6" opening for turning in 1 long side. Do not turn right side out.
- 17.** Insert the outer bag into the bag lining with right sides together, carefully aligning the side seams. Stitch around the top edges.
- 18.** Pull the outer bag through the opening in the lining bottom. Hand-stitch the opening closed.
- 19.** Insert the lining into the bag, smoothing it into the bottom corners. Hand-tack the bottom corners to hold in place, if desired.
- 20.** Press the top edge. Topstitch  $\frac{1}{4}$ " from the pressed edge.
- 21.** With right sides together, stitch the Fabric A bottom insert pieces together, leaving 1 end open. Turn right side out. Insert the  $4\frac{1}{2}$ " x  $14\frac{1}{2}$ " piece of cardboard into the sleeve. Turn the opening edges in and hand-stitch closed. Place the insert into the bottom of the bag to finish.

*While all possible care has been taken to ensure the accuracy of this pattern, we are not responsible for printing errors or the way in which individual work varies.*